

SAILBOAT

Proven engines, saildrives and options for all conditions



Great equipment. Great sailing.

For a sailor there is no better feeling than the wind in your sails, the sun on your face and a boat perfectly trimmed. Could it be this feeling that made you fall in love with sailing in the first place? Probably. However, one thing is for sure, with Volvo Penta equipment onboard you can relax and enjoy these moments for what they really are: exciting, relaxing and simply great sailing.

Whether you need a dependable saildrive system, state-of-the-art electronic monitoring software or some ergonomic controls specially designed for sailboats, you will find the answer in our equipment range.

Innovation is the key here. We are always looking for new ways to make your boating experience easier and more pleasurable – even in the most extreme situations.

Take the Volvo Ocean Race, for example – around 39,000 nautical miles of extreme product testing. One single standard Volvo Penta diesel engine powers everything onboard, in the world's toughest offshore race.

So after operating in such severe conditions, and during such a prolonged period of time, we can confidently deliver great equipment onboard your boat.





“From the modern pinch-to-zoom functionality of Glass Cockpit to the feel of our mechanical controls, Volvo Penta simplifies your sailboat experience.”

How to simplify your sailboat experience.



Freshwater cooling is standard.

Fast fuel bleeding.

Effective intake silencer contributes to low engine noise.

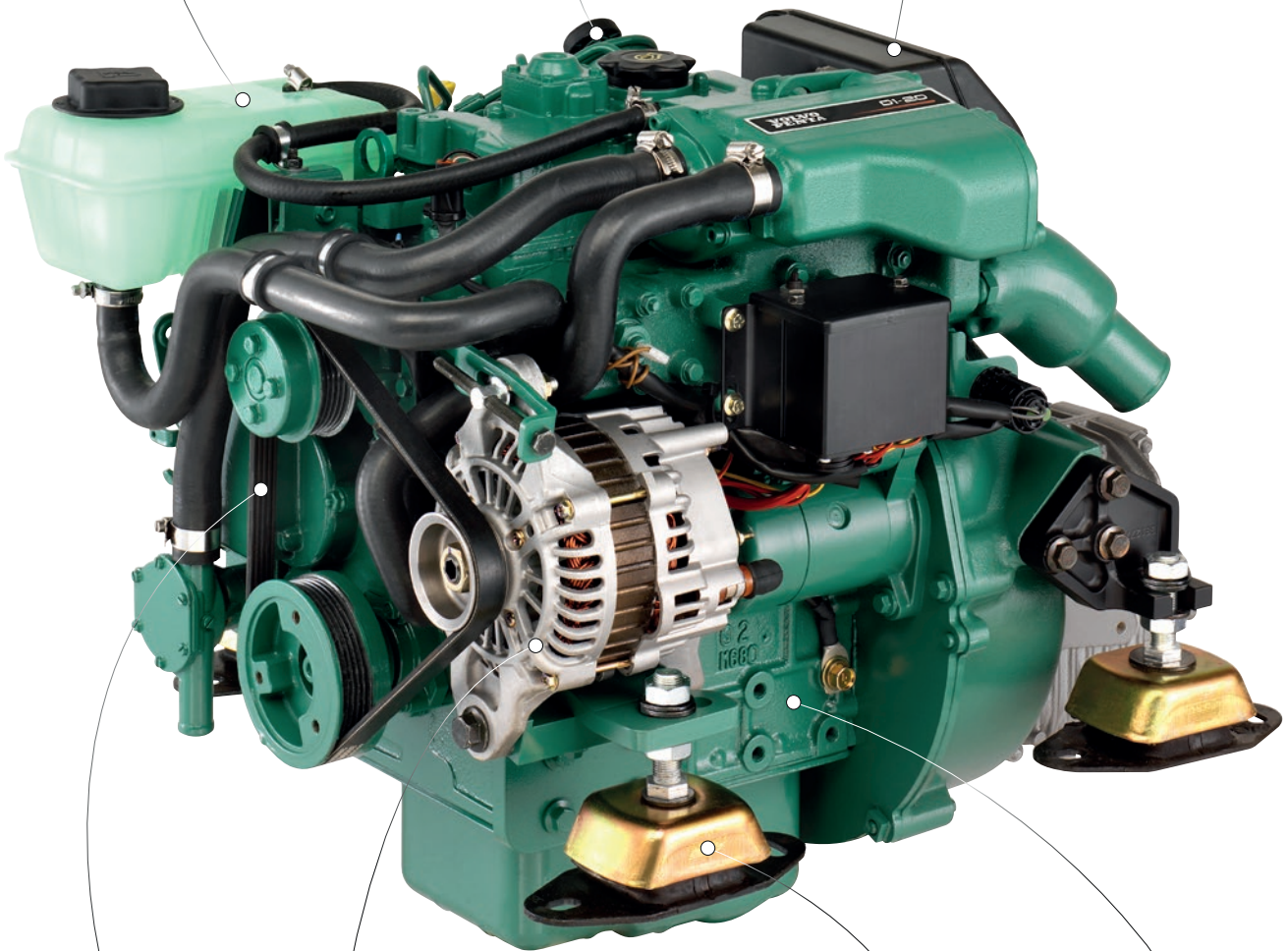

Durable multi V-belt with user-friendly tensioner.

115 A alternator with built-in charging sensor.



Engine suspension with large damping volume boosts comfort.

Rigid engine block for low noise.

World-renowned engine design

Whether installed in a Volvo Ocean Race yacht or in a private sailboat, Volvo Penta diesel engines have proven their reliability and efficiency all over the world. Our sailboat engines are well known throughout the international sailing community for their remarkable power and quiet operation.

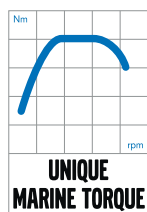

Torque for sailboats

Volvo Penta engines deliver high torque at low rpm. That means plenty of power and quick response when maneuvering in a marina.

Low rpm – high comfort

All engines are rated at low rpm, which means only 1,800–2,300 rpm at cruising speed. This results in minimal vibrations and low noise levels – which are further reduced with the Saildrive.

Reliable starts

With automatic pre-heating and the relay-activated starter solenoid, starts are reliable and fast. Electric stop is standard.

Efficient charging

Today's sailboats depend on electricity. All engines have high-capacity charging as standard. The 115A alternator has a built-in charging sensor that gives the correct battery charging voltage. The D3 has a 180A alternator. All models can have an extra engine-mounted alternator.

Specifications

Engines	Crankshaft kW/hp	Propeller shaft kW/hp	Rated rpm	Number of cylinders	Displacement, liters	Alternator 12 V
D1-13	9.0/12.2	8.6/11.8	3,200	2	0.5	115 A ⁽¹⁾
D1-20	14/19	13/18	3,200	3	0.8	115 A ⁽¹⁾
D1-30	21/28	20/27	3,200	3	1.1	115 A ⁽¹⁾
D2-40	29/40	28/38	3,200	4	1.5	115 A ⁽¹⁾
D2-55	41/55	39/53	3,000	4	2.2	115 A ⁽¹⁾
D2-75	55/75	53/72	3,000	4	2.2	115 A ⁽¹⁾
D3-110	81/110	78/107	3,000	5	2.4	180 A
D3-150	110/150	107/146	3,000	5	2.4	180 A
D4-180	132/180	128/174	2,800	4	3.7	115 A ⁽¹⁾

⁽¹⁾ With built-in charging sensor.

D1/D2 series

Extremely reliable, clean, quiet and with minimal vibrations. High torque at low revs gives easy maneuvering. Freshwater cooling is standard. Adapted for high-capacity hot-water supply.

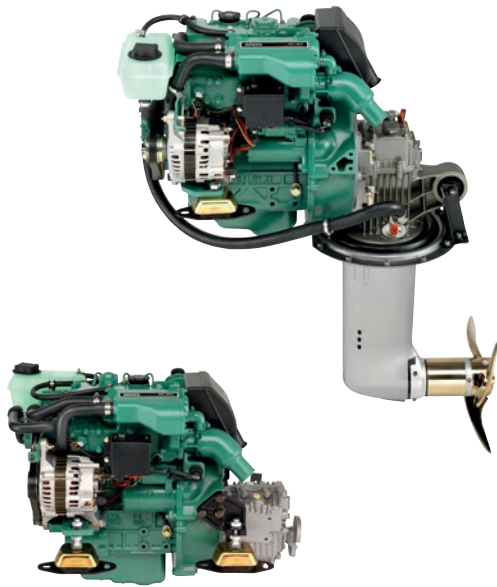

D1 series

The most compact engines in the range are 2 and 3-cylinder marine diesels available with Saildrive or a gearbox with straight or down-angled shaft.

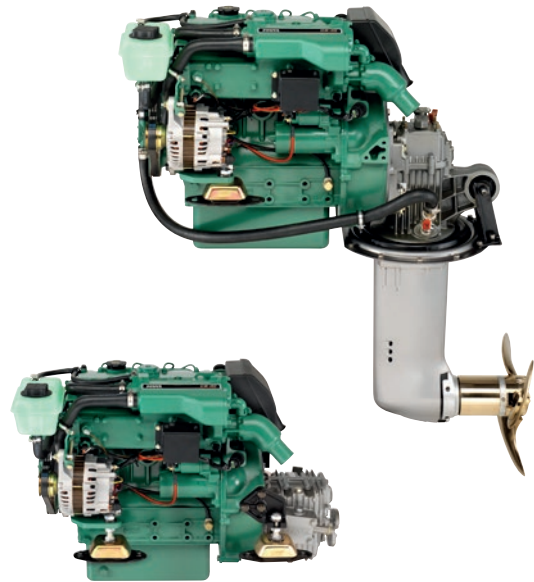

D2 series

4-cylinder marine diesels. Saildrive or a gearbox with straight or down-angled shaft.

D3/D4 series

Reliable common-rail marine diesels with impressive torque over the whole speed range. The D3/D4-series are powerful, quiet and fuel efficient with very low emissions and exceptional cruising range.



D3 series

5-cylinder diesel engines with 2.4-liter displacement. Extremely lightweight with turbo and aftercooler. Gearbox with down-angled shaft or V-drive.



D4 series

4-cylinder diesel engines with full 3.7-liter displacement. Turbo and aftercooler. Gearbox with down-angled shaft or V-drive.



The glory of repowering

Has your sailboat lost some of its former power and glory? A smart way to significantly improve its performance is to simply replace its engine.

A multitude of benefits

Repowering with a new Volvo Penta engine will increase the value of your boat, but you will also benefit from reduced fuel consumption and increased charging capacity, as well as reduced sound, vibration, and emission levels.

D1/D2 Repowering kit

This kit ensures a safe, easy, and cost-effective replacement with minimized fiberglass work. It's available for Volvo Penta engines in both shaft and Saildrive installations.

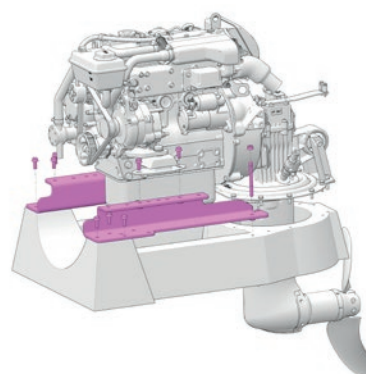

Service and support

Global service network

With every Volvo Penta product comes the support of a world-wide dealer network – present in more than 130 countries. These dealers are specialists in the maintenance and repair of your Volvo Penta products, using only genuine Volvo Penta parts.

Volvo Penta Action Service

This telephone service provides rapid support 24 hours a day, 365 days a year in 27 languages.

Warranty and Extended Coverage

Our warranty covers your whole engine package for 2 years, and major components for 3 additional years. With Extended Coverage, you will keep the full protection for the years 3–5 for a complete peace of mind. Extended Coverage must be purchased through your Volvo Penta dealer when the engine is ordered and/or commissioned.

Double your parts warranty

Genuine Volvo Penta Parts and Accessories are covered by our standard 12 month warranty. Have them supplied and installed by an authorized Volvo Penta dealer and we'll extend your warranty to 24 months – including the labor.



Volvo Penta shop

More than 100,000 parts and accessories are available to you in the Volvo Penta web shop at www.volvopentashop.com.

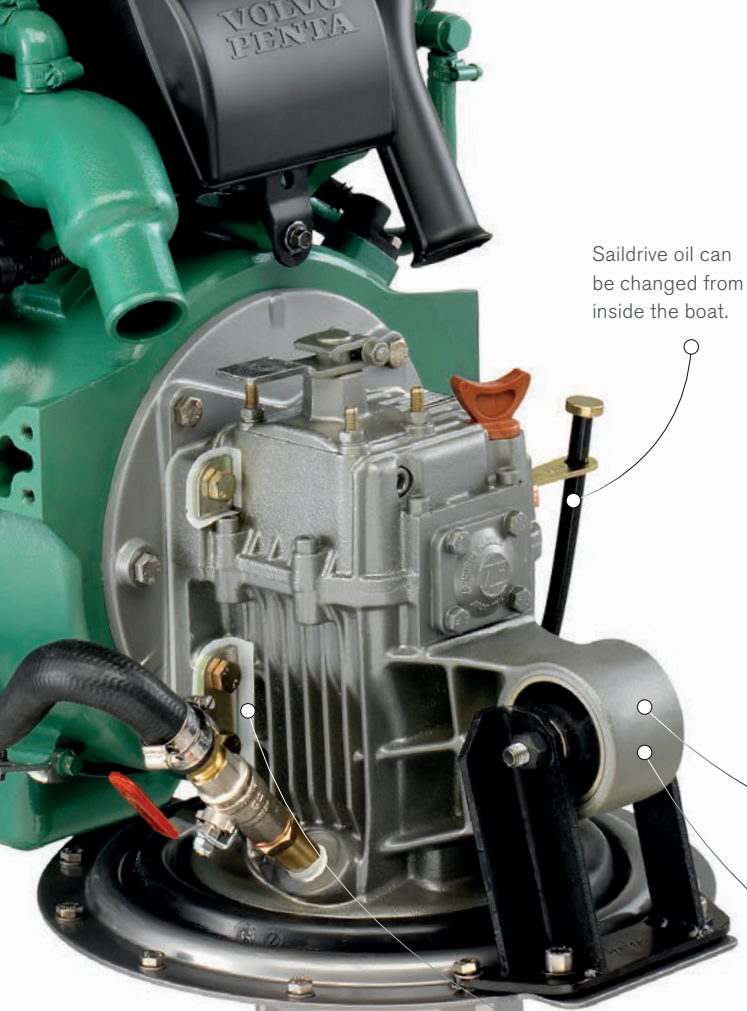

The original Saildrive

Whether you are a newcomer or seasoned sailor, you want a highly efficient engine, drive and propeller package for responsive and powerful maneuvering – a Volvo Penta Saildrive. Years of product development have created a drive with low underwater resistance and highly effective propulsion. And because we understand the needs of the modern sailor, we've incorporated a whole host of additional features.

Saildrive oil can be changed from inside the boat.

Three-point suspended mounting gives minimal noise and vibrations, with no need for alignment.

Crash absorber that keeps the engine in place in the event of impact.

Patented electrical isolation of drive and propeller to minimize risk of corrosion.

Hydrodynamically optimized design gives low drag while sailing.

The blades open and close using a reliable conical teeth mechanism.

Split anode that can be replaced without removing the propeller.

The folding propellers provide less drag, more power and reliable functionality.



Folding propellers

Less drag

A Volvo Penta folding propeller gives you up to 1.5 knots higher speed under sail compared with a fixed propeller. That will add greatly to your sailing pleasure.

More power

More power for maneuvering, the high thrust makes our propellers stand out from the competition. The patented elliptical blades give efficient thrust, even in reverse. The unique blade profile also provides safe opening when reversing.

Patented profile

The patented elliptical profile (high skew) of the propeller blades ensures effective, low-noise operation with minimal vibrations and no cavitation.

Special alloy

All Volvo Penta folding propellers are made of a specially developed, nickel-bronze-aluminum alloy to minimize corrosion and marine growth.



2-blade. For 13–40 hp.

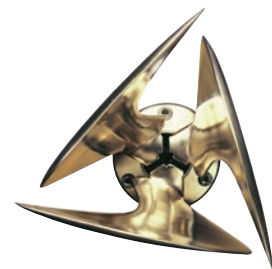

3-blade. For 20–75 hp.

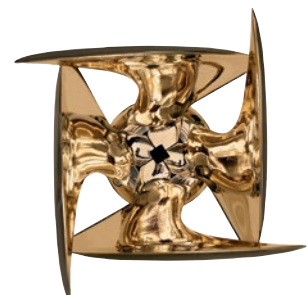

4-blade. For 55–75 hp.

Saildrive propellers	D1-13	D1-20	D1-30	D2-40	D2-55	D2-75
Folding propellers, 2-blade	○	○	○	○		
Folding propellers, 3-blade		○	○	○	○	○
Folding propellers, 4-blade					○	○
Fixed propellers	○	○	○	○	○	○

Folding propellers are also available for shaft installations.

Options for sailors and crew

In addition to our range of high-performing engines, drives and propellers, we offer sailors and their crew a wide range of options for increased comfort, safety and control. Below is a selection that will help make your sailing experience even more enjoyable. See www.volvopentashop.com for more parts and accessories.

EVC for D3 and D4 engines

EVC is Volvo Penta's electronic platform with radically reduced wiring and heavy-duty marine connectors. EVC provides greatly improved reliability and new functionalities:

- Continuous monitoring and protection of engine and transmission.
- Greatly improved reliability and service life compared with traditional electrical systems.

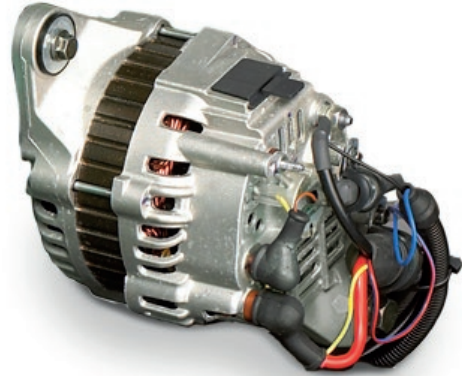

Chart plotter interface

The optional NMEA 2000 interface lets you have engine data displayed in a compatible chart plotter.

Extra alternator

Volvo Penta engines have alternators that are perfectly matched to the torque of the engine to provide extra charging without losing maneuvering power. Upgrading with an extra alternator will give high-capacity charging for 12V and 24V systems.



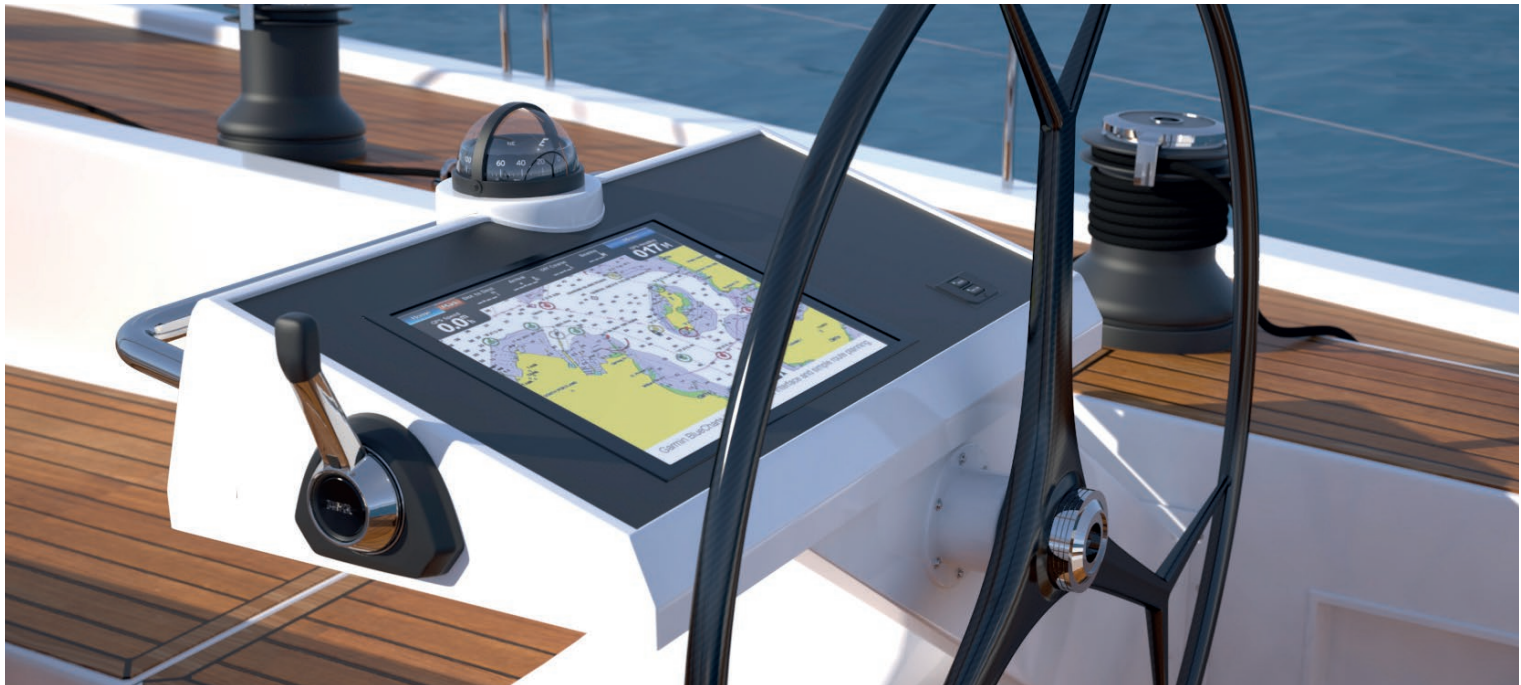

Glass cockpit

The D3 and D4 engines offer full EVC integration that allows for a unique Glass Cockpit solution – and a clean and clear dashboard. With the Glass Cockpit you can gather all driver information in one place for instant control: the easy-to-handle, pinch-to-zoom display.

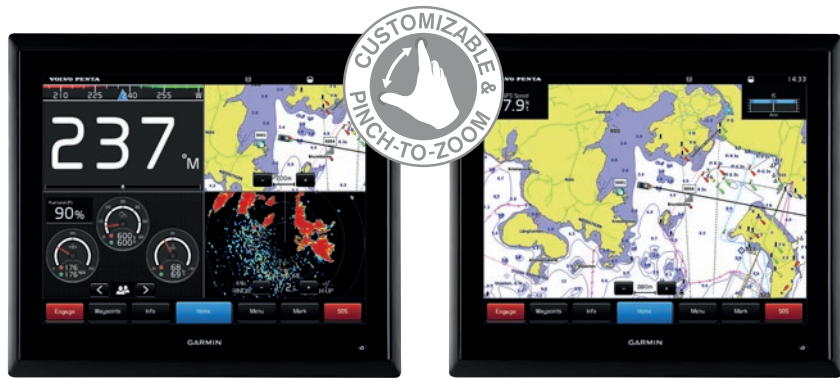

Optimized controls

The Volvo Penta controls, with ergonomic design and solid feel, are specially designed for reliable operation in sailboats.



Electronically operated (EVC), side-mounted controls for the D3/D4 series.



Compact design – minimal risk for entanglement.

The handle and cover plate are made of polished, stainless, high-quality steel.

The control comes splash-protected with two integrated sealing rings and a rubber cap. Upgrading older installations is simple.

Mechanically operated, side-mounted controls for the D1/D2 series.

**VOLVO
PENTA**

www.volvopenta.com